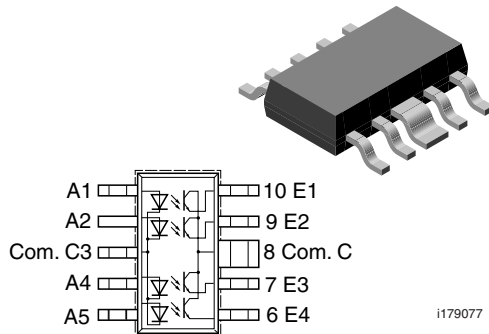


# Optocoupler, Phototransistor Output, SOT-223/10, Quad Channel



i179077

## DESCRIPTION

The SFH6943A is a four channel mini-optocoupler suitable for high density packaged PCB application. It has a minimum of 1768  $V_{RMS}$  isolation from input to output. The device consists of four phototransistors as detectors. Each channel is individually controlled. The optocoupler is housed in a SOT-223/10 package. All the cathodes of the input LEDs and all the collectors of the output transistors are common enabling a pin count reduction from 16 pins to 10 pins a significant space savings as compared to four channels that are electrically isolated individually.

## FEATURES

- Transistor optocoupler in SOT-223/10 package
- End stackable, 1.27 mm spacing
- Low current input
- Good CTR linearity versus forward current
- Minor CTR degradation
- High collector emitter voltage,  $V_{CEO} = 70\text{ V}$
- Low coupling capacitance
- High common mode transient immunity
- Isolation test voltage: 1768  $V_{RMS}$
- Compliant to RoHS directive 2002/95/EC and in accordance to WEEE 2002/96/EC


**RoHS**  
COMPLIANT

## APPLICATIONS

- Telecommunication
- SMT
- PCMCIA
- Instrumentation

## AGENCY APPROVALS

- UL1577, file no. E52744 system code V
- CSA 93751

## ORDER INFORMATION

PART	REMARKS
SFH6943A-2	CTR 63 % to 200 %, SMD-10
SFH6943A-3	CTR 100 % to 320 %, SMD-10

## ABSOLUTE MAXIMUM RATINGS (1)

PARAMETER	TEST CONDITION	SYMBOL	VALUE	UNIT
<b>INPUT</b>				
Reverse voltage		$V_R$	3	V
DC forward current		$I_F$	3	mA
Surge forward current	$t_p \leq 10\ \mu\text{s}$	$I_{FSM}$	100	mA
Total power dissipation		$P_{diss}$	10	mW
<b>OUTPUT</b>				
Collector emitter voltage		$V_{CE}$	70	V
Emitter collector voltage		$V_{EC}$	7	V
Collector current		$I_C$	10	mA
Surge collector current	$t_p < 1\ \text{ms}$	$I_{FSM}$	20	mA
Total power dissipation		$P_{diss}$	20	mW

ABSOLUTE MAXIMUM RATINGS (1)				
PARAMETER	TEST CONDITION	SYMBOL	VALUE	UNIT
<b>COUPLER</b>				
Isolation test voltage between emitter and detector	$t = 1 \text{ s}$	$V_{ISO}$	1768	$V_{RMS}$
Creepage distance			$\geq 4$	mm
Clearance distance			$\geq 4$	mm
Comparative tracking index per DIN IEC 112/VDE 0303, part 1		CTI	175	
Isolation resistance	$V_{IO} = 100 \text{ V}, T_{amb} = 25 \text{ }^\circ\text{C}$	$R_{IO}$	$\geq 10^{11}$	$\Omega$
	$V_{IO} = 100 \text{ V}, T_{amb} = 100 \text{ }^\circ\text{C}$	$R_{IO}$	$\geq 10^{10}$	$\Omega$
Storage temperature range		$T_{stg}$	- 55 to + 150	$^\circ\text{C}$
Ambient temperature range		$T_{amb}$	- 55 to + 100	$^\circ\text{C}$
Junction temperature		$T_j$	100	$^\circ\text{C}$
Soldering temperature, dip soldering plus reflow soldering processes (2)	$t = 10 \text{ s maximum}$	$T_{sld}$	260	$^\circ\text{C}$

**Notes**(1)  $T_{amb} = 25 \text{ }^\circ\text{C}$ , unless otherwise specified.

Stresses in excess of the absolute maximum ratings can cause permanent damage to the device. Functional operation of the device is not implied at these or any other conditions in excess of those given in the operational sections of this document. Exposure to absolute maximum ratings for extended periods of the time can adversely affect reliability.

(2) Refer to reflow profile for soldering conditions for surface mounted devices.

ELECTRICAL CHARACTERISTICS						
PARAMETER	TEST CONDITION	SYMBOL	MIN.	TYP.	MAX.	UNIT
<b>INPUT</b>						
Forward voltage	$I_F = 3 \text{ mA}$	$V_F$		1.25		V
Reverse current	$V_R = 3 \text{ V}$	$I_R$		0.01	10	$\mu\text{A}$
Capacitance	$V_R = 0 \text{ V}, f = 1 \text{ MHz}$	$C_O$		5		pF
Thermal resistance		$R_{thja}$		1000		K/W
<b>OUTPUT</b>						
Collector emitter voltage	$I_{CE} = 10 \text{ } \mu\text{A}$	$V_{CEO}$	70			V
Emitter collector voltage	$I_{EC} = 10 \text{ } \mu\text{A}$	$V_{ECO}$	7			V
Collector emitter capacitance	$V_{CE} = 5 \text{ V}, f = 1 \text{ MHz}$	$C_{CE}$		6		pF
Thermal resistance		$R_{thja}$		500		K/W
Collector emitter leakage current	$V_{CE} = 10 \text{ V}$	$I_{CEO}$		50		nA
<b>COUPLER</b>						
Coupling capacitance		$C_C$		1		pF

**Note** $T_{amb} = 25 \text{ }^\circ\text{C}$ , unless otherwise specified.

Minimum and maximum values are testing requirements. Typical values are characteristics of the device and are the result of engineering evaluation. Typical values are for information only and are not part of the testing requirements.

CURRENT TRANSFER RATIO							
PARAMETER	TEST CONDITION	PART	SYMBOL	MIN.	TYP.	MAX.	UNIT
Coupling transfer ratio	$I_F = 1 \text{ mA}, V_{CE} = 1.5 \text{ V}$	SFH6943A-2	$I_E/I_F$	63		200	%
		SFH6943A-3	$I_E/I_F$	100		320	%
	$I_F = 0.5 \text{ mA}, V_{CC} = 5 \text{ V}$	SFH6943A-2	$I_E/I_F$	32	100		%
		SFH6943A-3	$I_E/I_F$	50	160		%

SWITCHING CHARACTERISTICS						
PARAMETER	TEST CONDITION	SYMBOL	MIN.	TYP.	MAX.	UNIT
Turn-on time	$I_E = 2 \text{ mA}$ , $R_E = 100 \Omega$ , $V_{CC} = 5 \text{ V}$	$t_{on}$		3		$\mu\text{s}$
Rise time	$I_E = 2 \text{ mA}$ , $R_E = 100 \Omega$ , $V_{CC} = 5 \text{ V}$	$t_r$		2.6		$\mu\text{s}$
Turn-off time	$I_E = 2 \text{ mA}$ , $R_E = 100 \Omega$ , $V_{CC} = 5 \text{ V}$	$t_{off}$		3.1		$\mu\text{s}$
Fall time	$I_E = 2 \text{ mA}$ , $R_E = 100 \Omega$ , $V_{CC} = 5 \text{ V}$	$t_f$		2.8		$\mu\text{s}$

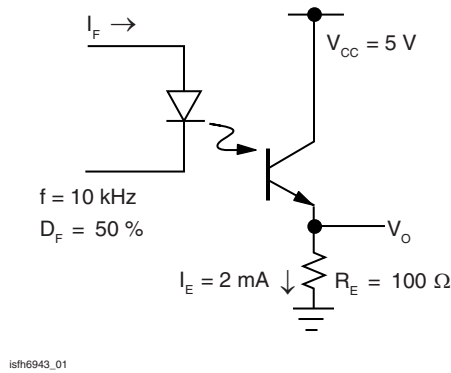
**TYPICAL CHARACTERISTICS**
 $T_{amb} = 25 \text{ }^\circ\text{C}$ , unless otherwise specified


Fig. 1 - Switching times (typ.)

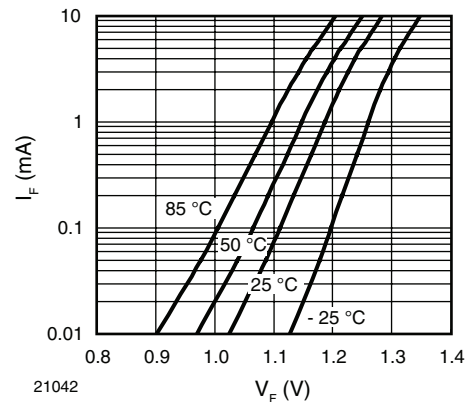


Fig. 3 - LED Current vs. LED Voltage

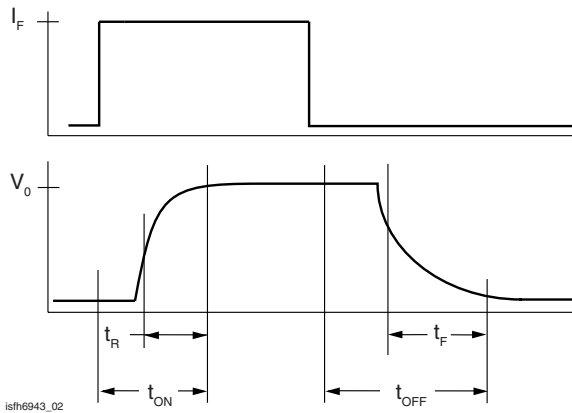


Fig. 2 - Switching Waveform

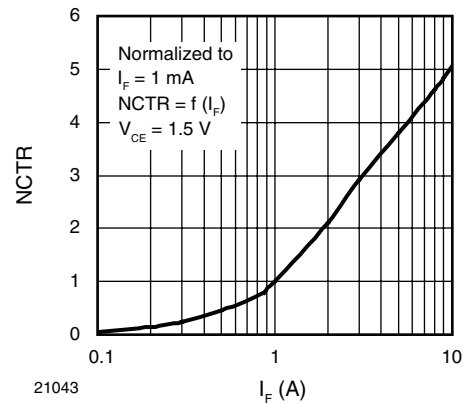


Fig. 4 - Non-Saturated Current Transfer

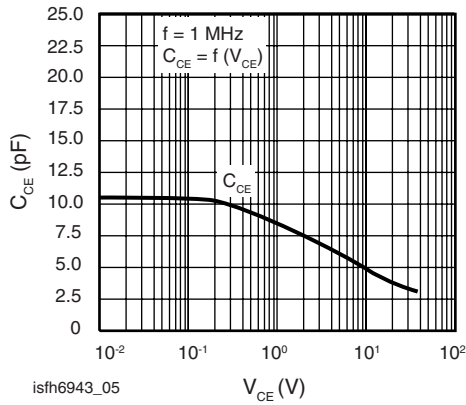


Fig. 5 - Transistor Capacitances (Typ.)

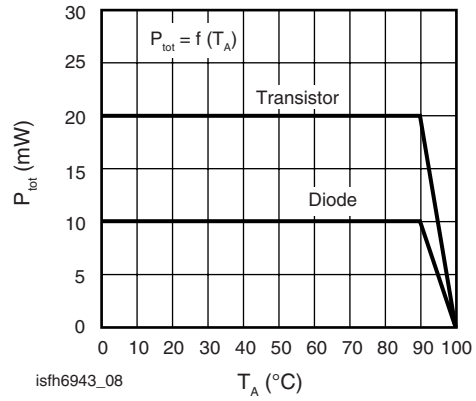


Fig. 8 - Permissible Power Dissipation

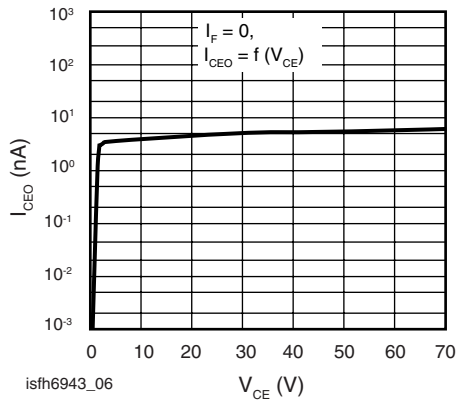


Fig. 6 - Collector Emitter Leakage Current (typ.)

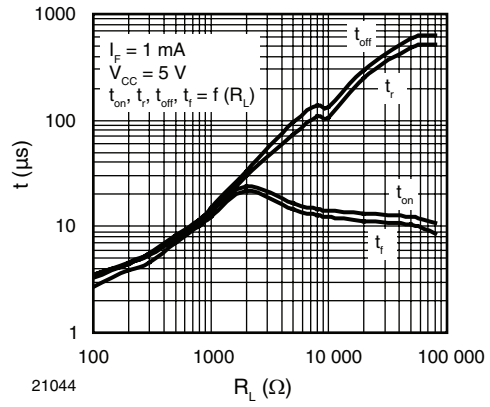


Fig. 9 - Switching Time

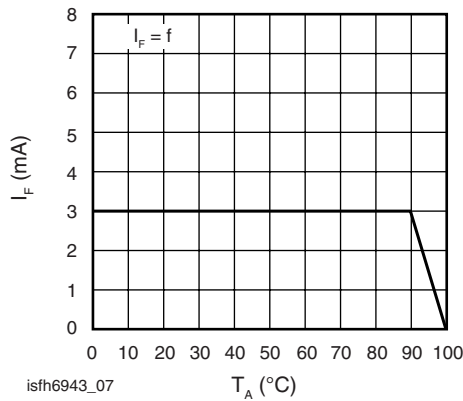


Fig. 7 - Permissible Forward Current Diode

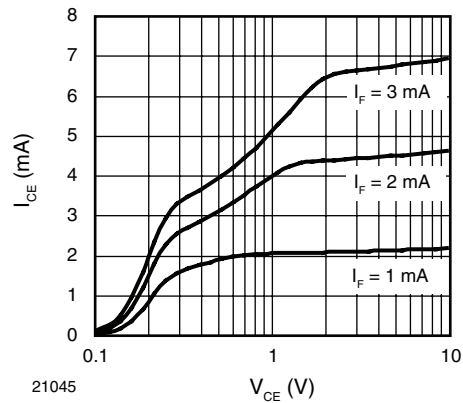
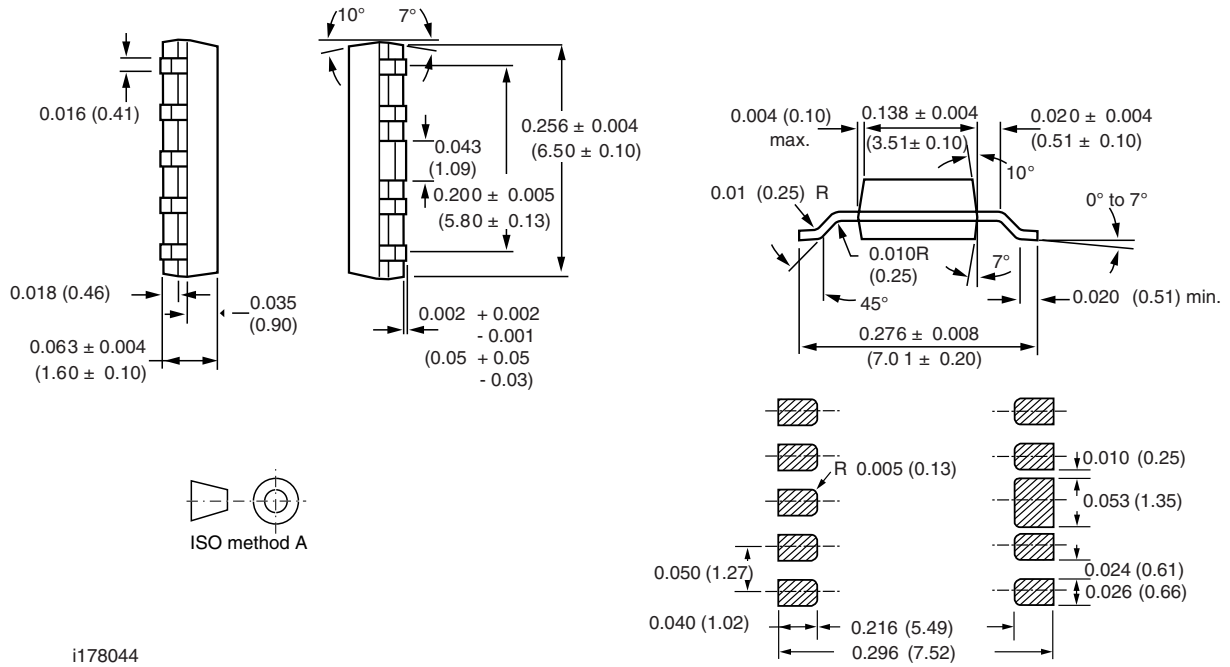


Fig. 10 - Transistor Output Characteristics



Optocoupler, Phototransistor Output, Vishay Semiconductors  
SOT-223/10, Quad Channel

**PACKAGE DIMENSIONS** in inches (millimeters)



i178044



## Disclaimer

All product specifications and data are subject to change without notice.

Vishay Intertechnology, Inc., its affiliates, agents, and employees, and all persons acting on its or their behalf (collectively, "Vishay"), disclaim any and all liability for any errors, inaccuracies or incompleteness contained herein or in any other disclosure relating to any product.

Vishay disclaims any and all liability arising out of the use or application of any product described herein or of any information provided herein to the maximum extent permitted by law. The product specifications do not expand or otherwise modify Vishay's terms and conditions of purchase, including but not limited to the warranty expressed therein, which apply to these products.

No license, express or implied, by estoppel or otherwise, to any intellectual property rights is granted by this document or by any conduct of Vishay.

The products shown herein are not designed for use in medical, life-saving, or life-sustaining applications unless otherwise expressly indicated. Customers using or selling Vishay products not expressly indicated for use in such applications do so entirely at their own risk and agree to fully indemnify Vishay for any damages arising or resulting from such use or sale. Please contact authorized Vishay personnel to obtain written terms and conditions regarding products designed for such applications.

Product names and markings noted herein may be trademarks of their respective owners.